

## SPECIFICATION

### STATIC DIMENSIONS

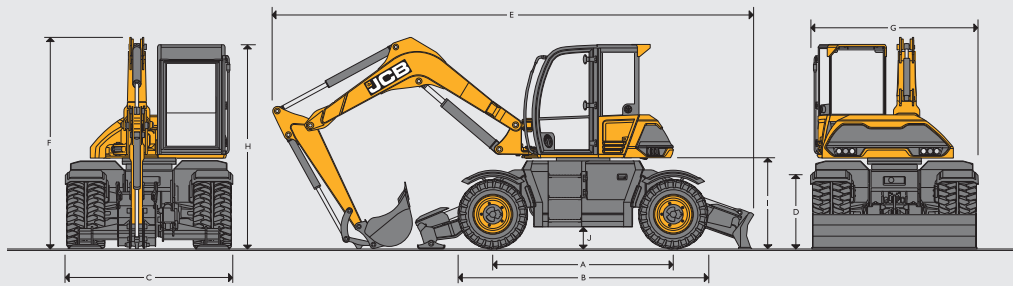

A	Wheelbase	mm	2650
B	Length over tyres	mm	3689
C	Width over tyres	mm	2420
D	Height over tyres	mm	1016
G	Transport width	mm	2440
H	Height over cab	mm	2988
I	Clearance under counterweight	mm	1319
J	Ground clearance	mm	298

		TAB		
Dipper lengths		1.65m	2.0m	2.25m
E	Roading length	mm	5899	5899
E	Transport length	mm	7654	7730
F	Roading height	mm	3907	3907
F	Transport height	mm	2988	2988

		Monoboomb		
Dipper lengths		1.65m	2.0m	2.25m
E	Roading length	mm	6406	6406
E	Transport length	mm	7050	6944
F	Roading height	mm	3973	3973
F	Transport height	mm	3132	3437

\*Machine is specified with a rear dozer blade. Please check chassis options for alternative specification dimensions.

### CHASSIS OPTIONS

Any combination of dozer (parallel/radial), stabiliser or grab stowage bar are available to both front and/or rear of chassis.

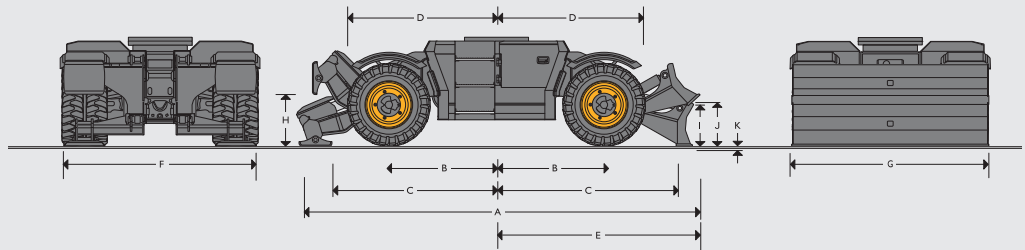

Front axle / rear axle	Oscillating steering axle / rigid steering axle		
Axes load capacity	14 tonnes		
Axes load oscillation	+/- 8 degrees		
Transmission	Hydrostatic drive via piston motor and stepless transmission		
A	Overall length		
	Rear stabiliser only	mm	4119
	Rear dozer only (raised)	mm	Parallel: 4342, Radial: 4319
	Front dozer and rear stabiliser (raised)	mm	Parallel: 4773, Radial: 4749
	Front and rear stabiliser (raised)	mm	4550
B	Centre of slew ring to front and rear axle	mm	1325
C	Centre of slew ring to front stabiliser (rear stabiliser)	mm	2275
D	Centre of slew ring to front tyre face	mm	1844
E	Centre of slew ring to rear dozer blade (lowered)	mm	Parallel: 2498, Radial: 2431
F	Width over stabilisers		2380
G	Width over dozer blade		2430
H	Stabiliser lift height		652
I	Dozer Lift height (clearance)		Parallel: 440, Radial: 501
J	Dozer Blade height (lowered)		505
K	Dozer Dig depth		Parallel: 160, Radial: 169

<b>TURNING RADIUS</b>		
	To outside of tyres	To outer edge of front mounted dozer blade
	4-Wheel Steer (mm)	4-Wheel Steer (mm)
Dual wheels	4163	4650
Single wheels	3946	4511
Floatation wheels	3946	4511

<b>MAIN HYDRAULIC SYSTEM</b>	
System	Electronically controlled system using two variable displacement piston pumps plus twin gear pumps for steering, brakes and cooling
<b>Services pump</b>	72cc variable displacement axial piston pump
Flow rate @ 2200rpm	158,4 l/min
Excavator main relief pressure	280 bar
<b>Transmission pump – 40kph</b>	85cc variable displacement axial piston pump in a closed loop hydrostatic drive system independent from working hydraulics
Flow rate @ 2200rpm	187 l/min
Transmission absolute pressure	525 bar
<b>Transmission pump – 20kph</b>	65cc variable displacement axial piston pump in a closed loop hydrostatic drive system independent from working hydraulics
Flow rate @ 2200rpm	143 l/min
Transmission absolute pressure	525 bar
<b>High flow auxiliary</b>	
High flow auxiliary pressure	210 bar
High flow auxiliary max. flow	120 l/min
<b>Low flow auxiliary</b>	
Low flow auxiliary pressure	210 bar
Low flow auxiliary max. flow	60 l/min
Second low flow auxiliary pressure	210 bar
Second low flow auxiliary max. flow	60 l/min
<b>Hydraulic cylinders</b>	Hardened, chromed piston rods with end damping on boom raise and dipper in
<b>Filtration</b>	
In tank	125 micron suction strainer
Main return line	10 micron return line filter

<b>SERVICE CAPACITIES</b>		
Fuel tank	litres	162
Engine coolant	litres	28
Engine oil	litres	14
Hydraulic system	litres	190
Hydraulic tank	litres	130
Transmission (dropbox)	litres	1,0
Axle differentials (each)	litres	Front = 18, rear = 14
Axle hubs (each)	litres	2,0

<b>TYRES</b>			
	Dual	Single	Floatation
Type	9,00x20 tyres with spacer ring	405/70 x 20 tyres	500/45 x22.5tyres
Inflation pressure	7,0 bar	4,0 bar	3,8 bar
Ply rating	14PR	16PR	16PR

<b>ENGINE</b>	
Model	JCB EcoMAX 444 TCA-99 Eu Stage IIIB, EPA Tier 4 Interim Compliant
Type	Water cooled, 4-stroke, 4-cylinder in-line, direct injection, turbocharged diesel
Rated power (ISO 14396)	81 kW (109 hp) @ 2200 rpm
Gross torque (ISO 14396)	516 Nm @ 1500 rpm
Piston displacement	4,4 litres
Air filtration	Dry element with secondary safety element and in-cab warning sensor
Starting system	12 volt
Batteries	12 volt
Alternator	12 volt, 150 ampere

<b>SLEW SYSTEM</b>	
Drive train	Axial piston type
Slew brake	Hydraulic braking plus automatic spring applied disc type parking brake
Slew torque	27,0 kNm
Slew speed	8,9 rpm
Slew gear	11 tooth pinion / 84 tooth ring

<b>TRAVEL SPEED</b>	
Max. roading speed	40 kp/h
Drawbar pull	45 kNm
Steering	Fully hydraulic system with 4-wheel steer, 2-wheel steer and crab steer

<b>BRAKES</b>	
Brakes	All hydraulic dual circuit brake system with positive brake back off
Parking brake	Built into the transmission
Gradability	26,6° / 50% maximum continuous

## SPECIFICATION

### OPERATING WEIGHTS

Machine equipped with no bucket, 75kg operator, 154kg fuel, dual tyres, 2000mm dipper.

		Monoboom	TAB
No dozer, no stabiliser	kg	10208	10487
Rear parallel dozer	kg	10750	11029
Rear radial dozer	kg	10695	10974
Rear stabiliser	kg	10636	10915
Front parallel dozer and rear stabiliser	kg	11178	11457
Front radial dozer and rear stabiliser	kg	11123	11402
Front stabiliser and rear stabiliser	kg	11064	11343

### BUCKET AND ARM COMBINATIONS

Bucket options		GP Bucket							
		250	300	400	450	500	600	800	900
Bucket width	mm	250	300	400	450	500	600	800	900
Bucket capacity	m <sup>3</sup>	0,06	0,08	0,11	0,13	0,15	0,19	0,27	0,31
Bucket weight	kg	102	109	107	113	120	135	166	179
<b>Monoboom</b>									
1,65m		<input type="checkbox"/>	<input type="checkbox"/>	<input type="checkbox"/>	<input type="checkbox"/>	<input type="checkbox"/>	<input type="checkbox"/>	<input type="checkbox"/>	<input type="checkbox"/>
2,00m		<input type="checkbox"/>	<input type="checkbox"/>	<input type="checkbox"/>	<input type="checkbox"/>	<input type="checkbox"/>	<input type="checkbox"/>	<input type="checkbox"/>	<input type="checkbox"/>
2,25m		<input type="checkbox"/>	<input type="checkbox"/>	<input type="checkbox"/>	<input type="checkbox"/>	<input type="checkbox"/>	<input type="checkbox"/>	<input type="checkbox"/>	<input type="checkbox"/>
<b>T.A.B.</b>									
1,65m		<input type="checkbox"/>	<input type="checkbox"/>	<input type="checkbox"/>	<input type="checkbox"/>	<input type="checkbox"/>	<input type="checkbox"/>	<input type="checkbox"/>	<input type="checkbox"/>
2,00m		<input type="checkbox"/>	<input type="checkbox"/>	<input type="checkbox"/>	<input type="checkbox"/>	<input type="checkbox"/>	<input type="checkbox"/>	<input type="checkbox"/>	<input type="checkbox"/>
2,25m		<input type="checkbox"/>	<input type="checkbox"/>	<input type="checkbox"/>	<input type="checkbox"/>	<input type="checkbox"/>	<input type="checkbox"/>	<input type="checkbox"/>	<input type="checkbox"/>

= Material weight up to 2000kg/m<sup>3</sup>.

● = Material weight up to 1600kg/m<sup>3</sup>.

■ = Material weight up to 1200kg/m<sup>3</sup>.

The above are to subject to ground conditions and are a guide only.

WORKING RANGE – TAB

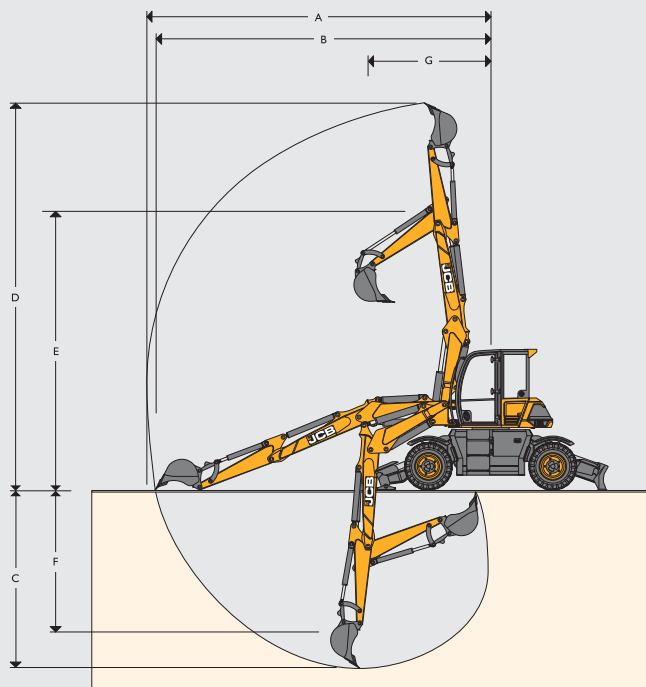





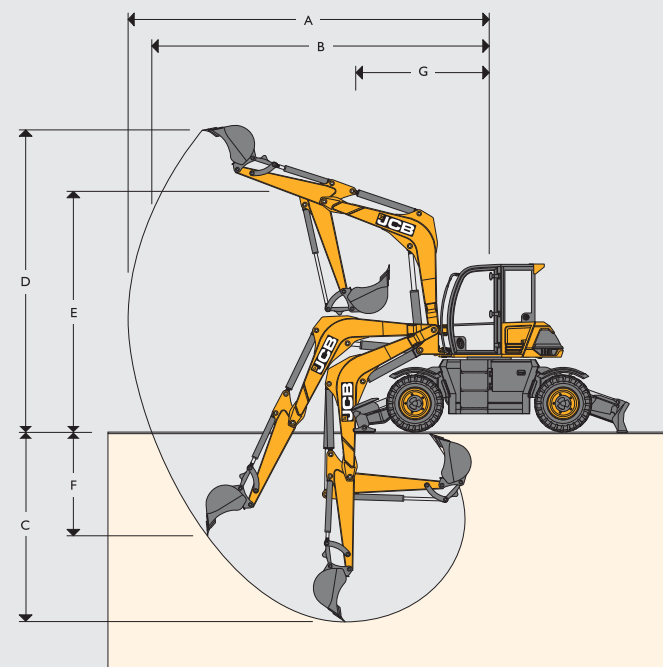





Dipper length		1.65m	2.0m	2.25m	
A	Max digging reach	mm	7420	7770	8020
B	Max digging reach (on ground)	mm	7165	7530	7785
C	Max digging depth	mm	3810	4160	4410
D	Max digging height	mm	8195	8545	8795
E	Max loadover height	mm	6380	6720	6965
F	Max vertical wall cut depth	mm	3000	3315	3540
G	Min swing radius	mm	2675	2920	3100
	Boom swing left	degrees	50		
	Boom swing right	degrees	70		
	Bucket rotation	degrees	184		
	Dipper tearout	kNm	48.3	42.3	39
	Bucket tearout	kNm	60.2		

WORKING RANGE – MONOBOOM



Dipper length		1.65m	2.0m	2.25m	
A	Max digging reach	mm	6455	6785	7020
B	Max digging reach (on ground)	mm	6085	6445	6695
C	Max digging depth	mm	3370	3720	3970
D	Max digging height	mm	6445	6645	6790
E	Max loadover height	mm	4710	4915	5060
F	Max vertical wall cut depth	mm	1815	2135	2360
G	Min swing radius	mm	2645	2685	2715
	Boom swing left	degrees	50		
	Boom swing right	degrees	70		
	Bucket rotation	degrees	184		
	Dipper tearout	kNm	48.3	42.3	39
	Bucket tearout	kNm	60.2		

**SPECIFICATION**

LIFT CAPACITIES: 1.65M DIPPER WITH STABS AND DOZER DEPLOYED											MONOBOOM
Reach	3m		4m		5m		6m		Capacity at Max Reach		
											
Load Point Ht.	kg	kg	kg	kg	kg	kg	kg	kg	kg	kg	mm
4.5m	-	-	-	-	-	-	-	-	1772*	1772*	4909
3.0m	2512*	2512*	2059*	2059*	-	-	-	-	1897*	1897*	5538
1.5m	4587*	4587*	2921*	2921*	2279*	1925	-	-	2069*	1605	5629
0m	5076*	4036	3350*	2593	2466*	1874	-	-	2306*	1760	5218
-1.0m	4733*	4048	3166*	2580	-	-	-	-	2518*	2117	4586

LIFT CAPACITIES: 1.65M DIPPER OFF DUAL TYRES											MONOBOOM
Reach	3m		4m		5m		6m		Capacity at Max Reach		
											
Load Point Ht.	kg	kg	kg	kg	kg	kg	kg	kg	kg	kg	mm
4.5m	-	-	-	-	-	-	-	-	1757*	1757*	4802
3.0m	2399*	2399*	1978*	1978*	-	-	-	-	1873*	1281	5500
1.5m	4410*	2976	2840*	1975	2240*	1423	-	-	2040*	1181	5642
0m	5110*	2845	3332*	1874	2463*	1367	-	-	2269*	1259	5284
-1.0m	4818*	2828	3224*	1856	-	-	-	-	2474*	1475	4708

LIFT CAPACITIES: 2.0M DIPPER WITH STABS AND DOZER DEPLOYED											MONOBOOM
Reach	3m		4m		5m		6m		Capacity at Max Reach		
											
Load Point Ht.	kg	kg	kg	kg	kg	kg	kg	kg	kg	kg	mm
4.5m	-	-	-	-	-	-	-	-	1599*	1599*	5298
3.0m	-	-	1765*	1765*	1696*	1696*	-	-	1585*	1585*	5879
1.5m	4153*	4153*	2692*	2692*	2138*	2138*	-	-	1733*	1463*	5966
0m	5027*	4017	3283*	2582	2427*	1853	-	-	2095*	1581	5583
-1.0m	4905*	4016	3251*	2545	2304*	1846	-	-	2285*	1839	5014











 Lift capacity front and rear.

 Lift capacity full circle.











Notes:

1. For lifting capacity including bucket, subtract total weight of bucket or bucket and quickhitch from above values.
2. Lifting capacities are based on ISO 10567, that is: 75% of minimum tipping load or 87% of hydraulic lift capacity, whichever is the less. Lifting capacities marked\* are based on hydraulic capacity.
3. Lift capacities assume that the machine is on firm, level ground.
4. Lift capacities may be limited by local regulations. Please refer to your dealer.











**LIFT CAPACITIES: 2.0M DIPPER OFF DUAL TYRES** **MONOBOOM**

Reach	3m		4m		5m		6m		Capacity at Max Reach		mm
											
Load Point Ht.	kg	kg	kg	kg	kg	kg	kg	kg	kg	kg	
4.5m	-	-	-	-	-	-	-	-	1580*	1580*	5202
3.0m	-	-	1679*	1679*	1660*	1660*	-	-	1577*	1161	5845
1.5m	3959*	3035	2612*	1991	2090*	1425	-	-	1696*	1073	5978
0m	5018*	2825	3250*	1867	2415*	1354	-	-	2059*	1130	5646
-1.0m	4949*	2793	3282*	1832	2354*	1339	-	-	2244*	1286	5119

**LIFT CAPACITIES: 2.25M DIPPER WITH STABS AND DOZER DEPLOYED** **MONOBOOM**

Reach	3m		4m		5m		6m		Capacity at Max Reach		mm
											
Load Point Ht.	kg	kg	kg	kg	kg	kg	kg	kg	kg	kg	
4.5m	-	-	-	-	1314*	1314*	-	-	1414*	1414	5574
3.0m	-	-	1550*	1550*	1548*	1548*	1588*	1588*	1388*	1388	6125
1.5m	3805*	3805*	2526*	2526*	2017*	2017*	1784*	1447	1504*	1504	6207
0m	4962*	4029	3199*	2570	2379*	1844	-	-	1833*	1468	5846
-1.0m	4959*	3983	3272*	2530	2369*	1826	-	-	2135*	1680	5305

**LIFT CAPACITIES: 2.25M DIPPER OFF DUAL TYRES** **MONOBOOM**

Reach	3m		4m		5m		6m		Capacity at Max Reach		mm
											
Load Point Ht.	kg	kg	kg	kg	kg	kg	kg	kg	kg	kg	
4.5m	-	-	-	-	1312*	1312*	-	-	1440*	1440*	5488
3.0m	-	-	1500*	1500*	1508*	1508*	1577*	1102	1382*	1082	6091
1.5m	3596*	3070	2423*	1999	1972*	1426	1763*	1065	1474*	1002	6218
0m	4923*	2828	3157*	1856	2360*	1347	-	-	1762*	1046	5903
-1.0m	5012*	2785	3285*	1816	2394*	1322	-	-	2093*	1174	5409











 Lift capacity front and rear.

 Lift capacity full circle.











- Notes:
1. For lifting capacity including bucket, subtract total weight of bucket or bucket and quickhitch from above values.
  2. Lifting capacities are based on ISO 10567, that is: 75% of minimum tipping load or 87% of hydraulic lift capacity, whichever is the less. Lifting capacities marked\* are based on hydraulic capacity.
  3. Lift capacities assume that the machine is on firm, level ground.
  4. Lift capacities may be limited by local regulations. Please refer to your dealer.

**SPECIFICATION**











**LIFT CAPACITIES: 1.65M DIPPER WITH STABS AND DOZER DEPLOYED TAB**

Reach	3m		4m		5m		6m		Capacity at Max Reach		
											
Load Point Ht.	kg	kg	kg	kg	kg	kg	kg	kg	kg	mm	
4.5m	1827*	1827*	2105*	2105*	1767*	1767*	-	-	1516*	1298	5964
3.0m	-	-	2566*	2212	1954*	1684	1512*	1277	1384*	1106	6518
1.5m	-	-	2913*	2188	2147*	1604	1625*	1232	1395*	1060	6632
0m	-	-	2691*	2129	2024*	1556	1500*	1213	1230*	1060	6339
-1.0m	2789*	2789*	2250*	1940	1695*	1461	-	-	1042*	1042*	5887

**LIFT CAPACITIES: 1.65M DIPPER OFF DUAL TYRES TAB**

Reach	3m		4m		5m		6m		Capacity at Max Reach		
											
Load Point Ht.	kg	kg	kg	kg	kg	kg	kg	kg	kg	mm	
4.5m	1827*	1827*	2105*	2105*	1767*	1422	-	-	1516*	1030	5964
3.0m	-	-	2566*	1886	1954*	1358	1512*	1018	1384*	878	6518
1.5m	-	-	2913*	1725	2147*	1276	1625*	983	1395*	845	6632
0m	-	-	2691*	1688	2024*	1242	1500*	971	1230*	909	6339
-1.0m	2789*	2789*	2250*	1719	1695*	1256	-	-	1042*	1042*	5887

**LIFT CAPACITIES: 2.00M DIPPER WITH STABS AND DOZER DEPLOYED TAB**

Reach	3m		4m		5m		6m		Capacity at Max Reach		
											
Load Point Ht.	kg	kg	kg	kg	kg	kg	kg	kg	kg	mm	
4.5m	-	-	1908*	1908*	-	-	1385*	1194	1336*	1152	6358
3.0m	-	-	2412*	2412*	1844*	1590	-	-	1232*	1006	6874
1.5m	-	-	2846*	2196	2095*	1596	1559*	1222	1241*	968	6982
0m	-	-	2766*	2104	2052*	1532	1568*	1191	1142*	985	6706
-1.0m	3182*	3182*	2406*	2074	1810*	1530	1275*	1099	991*	991*	6288











 Lift capacity front and rear.

 Lift capacity full circle.











Notes:

1. For lifting capacity including bucket, subtract total weight of bucket or bucket and quickhitch from above values.
2. Lifting capacities are based on ISO 10567, that is: 75% of minimum tipping load or 87% of hydraulic lift capacity, whichever is the less. Lifting capacities marked\* are based on hydraulic capacity.
3. Lift capacities assume that the machine is on firm, level ground.
4. Lift capacities may be limited by local regulations. Please refer to your dealer.











**LIFT CAPACITIES: 2.0M DIPPER OFF DUAL TYRES** **TAB**

Reach	3m		4m		5m		6m		Capacity at Max Reach		
											
Load Point Ht.	kg	kg	kg	kg	kg	kg	kg	kg	kg	kg	mm
4.5m	-	-	1908*	1908*	-	-	1385*	1043	1336*	919	6358
3.0m	-	-	2412*	1920	1844*	1365	-	-	1232*	795	6874
1.5m	-	-	2846*	1729	2095*	1268	1559*	972	1241*	766	6982
0m	-	-	2766*	1662	2052*	1219	1568*	949	1142*	818	6706
-1.0m	3182*	3182*	2406*	1673	1810*	1223	1275*	959	991*	991*	6288

**LIFT CAPACITIES: 2.25M DIPPER WITH STABS AND DOZER DEPLOYED** **TAB**

Reach	3m		4m		5m		6m		Capacity at Max Reach		
											
Load Point Ht.	kg	kg	kg	kg	kg	kg	kg	kg	kg	kg	mm
4.5m	-	-	1582*	1582*	1598*	1598*	1325*	1325*	1226*	1057	6636
3.0m	-	-	2149*	2149*	1770*	1526	1386*	1195	1135*	940	7127
1.5m	-	-	2777*	2204	2056*	1600	1512*	1217	1142*	906	7231
0m	-	-	2795*	2088	2063*	1520	-	-	1081*	932	6967
-1.0m	2908*	2908*	2500*	2078	1871*	1510	1369*	1171	950*	950*	6570

**LIFT CAPACITIES: 2.25M DIPPER OFF DUAL TYRES** **TAB**

Reach	3m		4m		5m		6m		Capacity at Max Reach		
											
Load Point Ht.	kg	kg	kg	kg	kg	kg	kg	kg	kg	kg	mm
4.5m	-	-	1582*	1582*	1598*	1598*	1325*	1052	1226*	848	6636
3.0m	-	-	2149*	2149*	1770*	1372	1386*	1018	1135*	740	7127
1.5m	-	-	2777*	1734	2056*	1270	1512*	965	1142*	713	7231
0m	-	-	2795*	1645	2063*	1204	-	-	1081*	759	6967
-1.0m	2908*	2908*	2500*	1646	1871*	1202	1369*	933	950*	950*	6570

 Lift capacity front and rear.

 Lift capacity full circle.

- Notes:
1. For lifting capacity including bucket, subtract total weight of bucket or bucket and quickhitch from above values.
  2. Lifting capacities are based on ISO 10567, that is: 75% of minimum tipping load or 87% of hydraulic lift capacity, whichever is the less. Lifting capacities marked\* are based on hydraulic capacity.
  3. Lift capacities assume that the machine is on firm, level ground.
  4. Lift capacities may be limited by local regulations. Please refer to your dealer.